

**ARR011**

Material: TPE

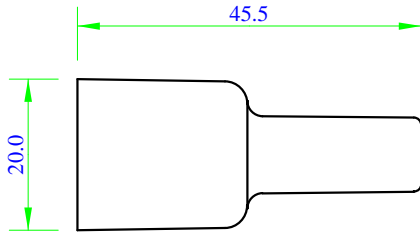

**Application:** Universal Distributor and Coil Boot

**ARR012**

Material: TPE

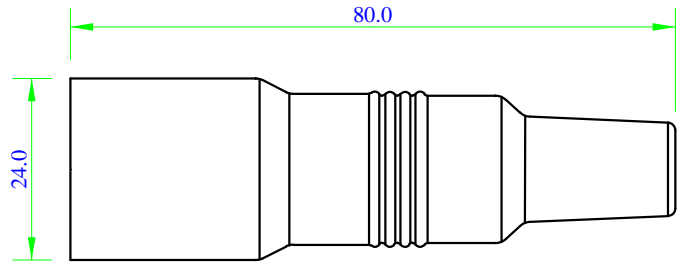

**Application:** BMW Distributor and Coil Boot

**ARR013**

Material: PVC

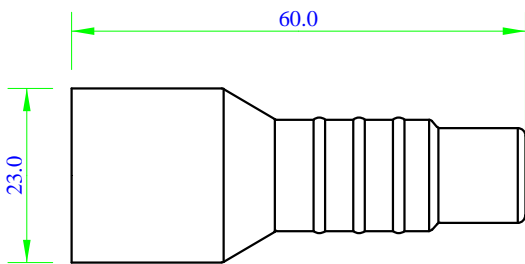

**Application:** GM Distributor and Coil Boot

**ARR014**

Material: TPE

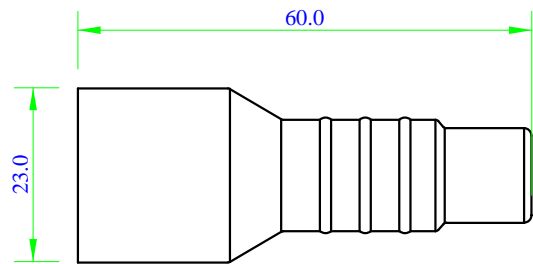

**Application:** GM Distributor and Coil Boot

**ARR015**

Material: TPE

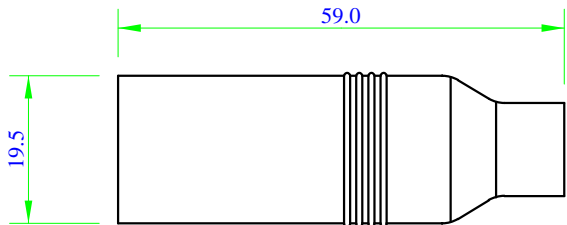

**Application:** Volkswagen Distributor and Coil Boot

**ARR016**

Material: TPE

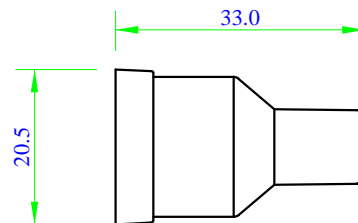

**Application:** Universal Distributor and Coil Boot

**ARR017**

Material: PVC

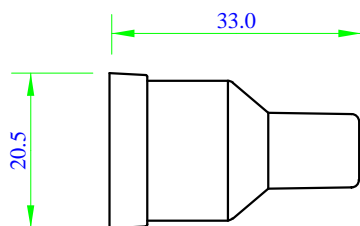

**Application:** Universal Distributor and Coil Boot

**ARR018**

Material: TPE

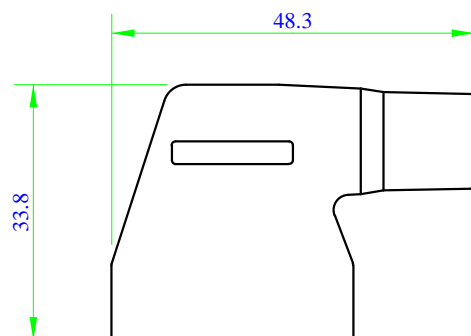

**Application:** Mazda/Ford Coil Boot